

NOTICE D'
installation

INFORMATIONS IMPORTANTES A LIRE ATTENTIVEMENT



Plinthes électriques

Éléments du kit

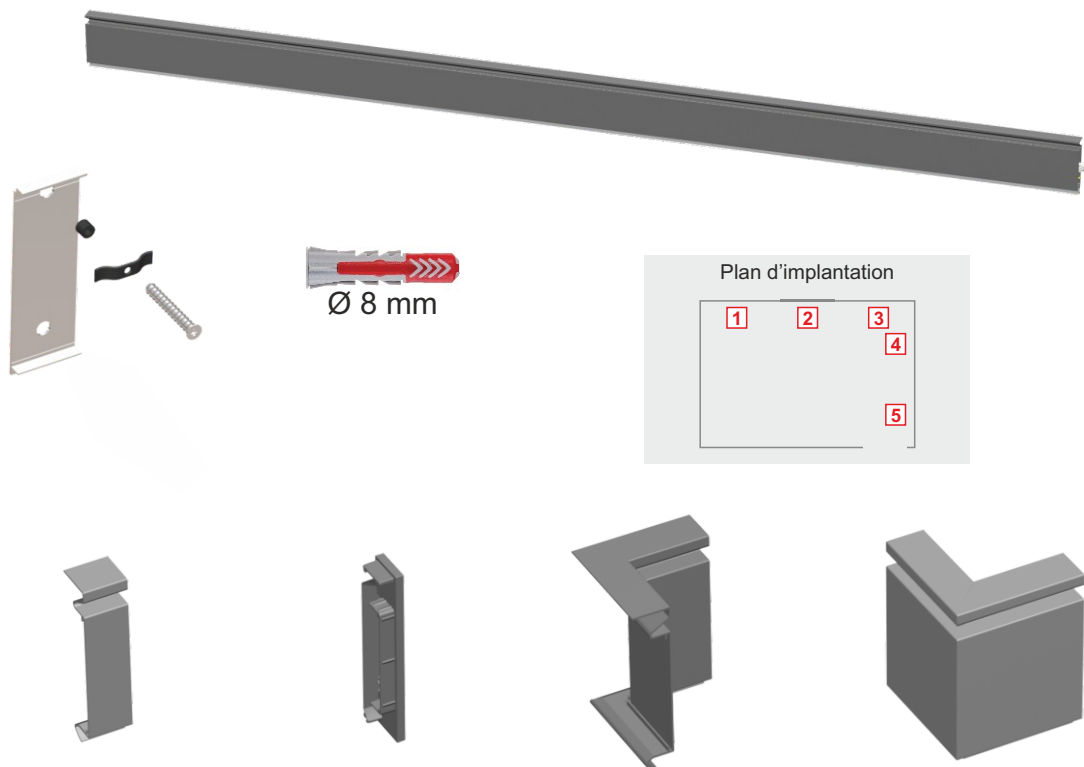

Outillage nécessaire



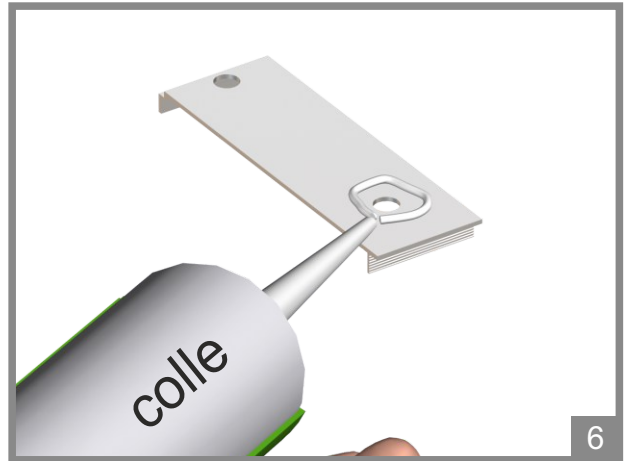
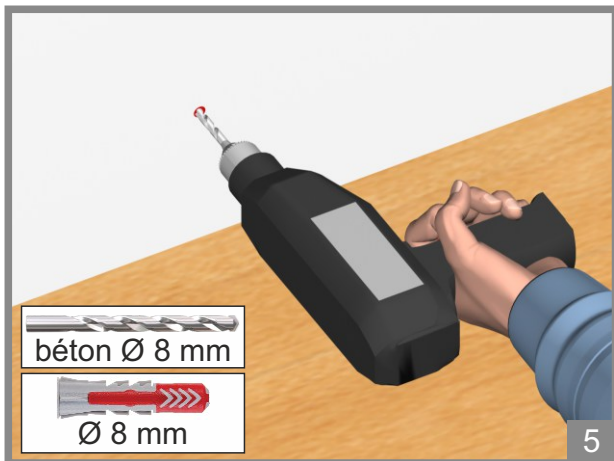
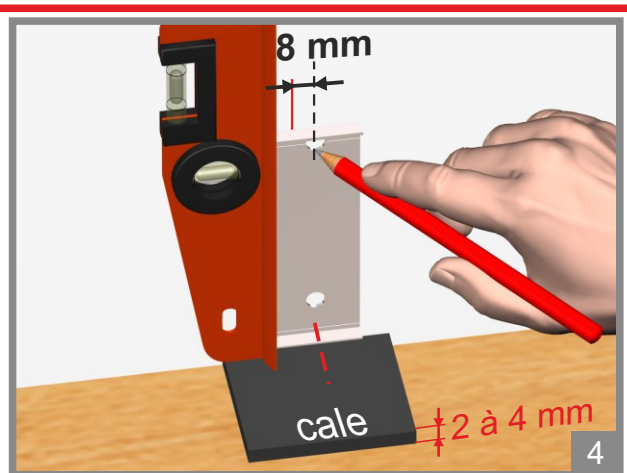
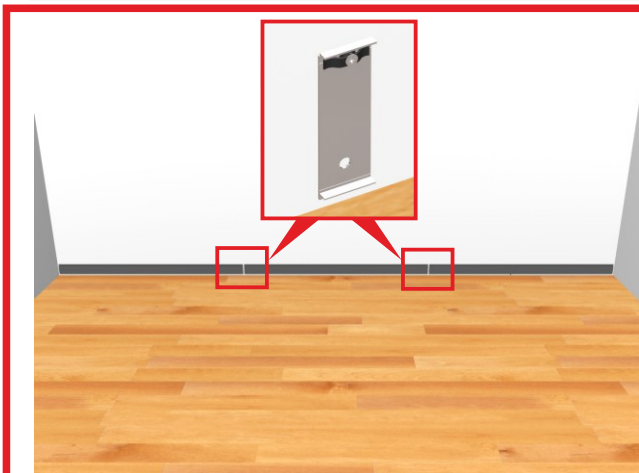
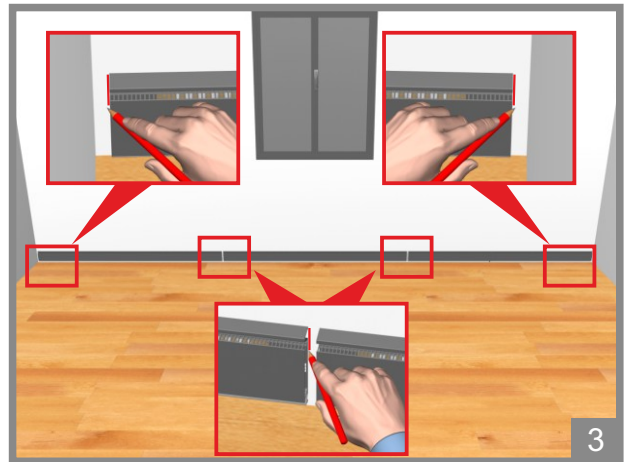
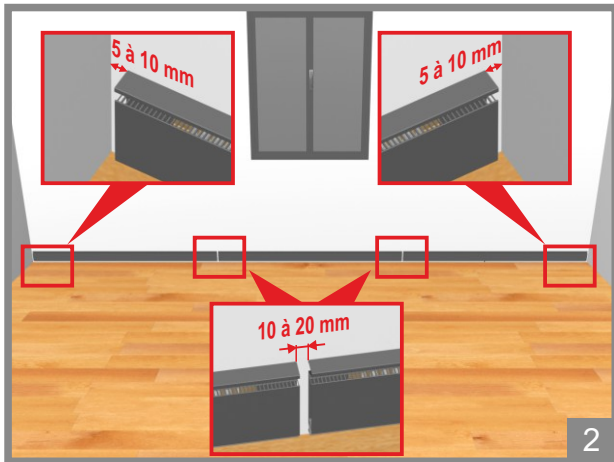
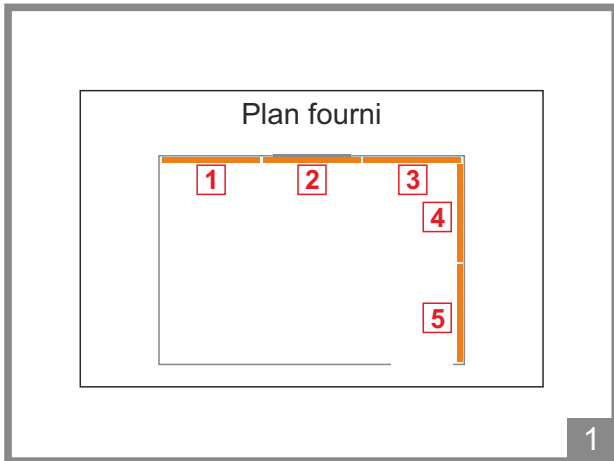

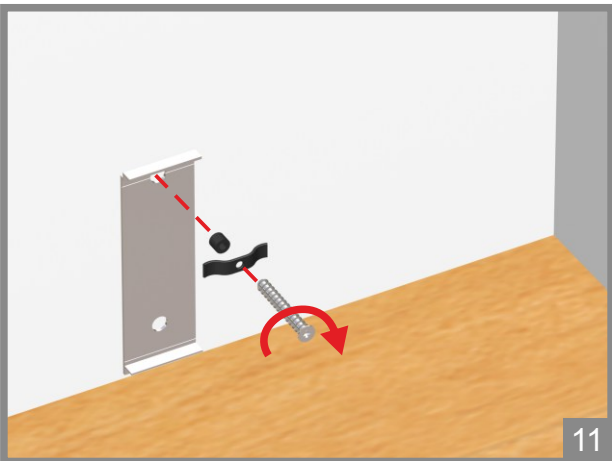
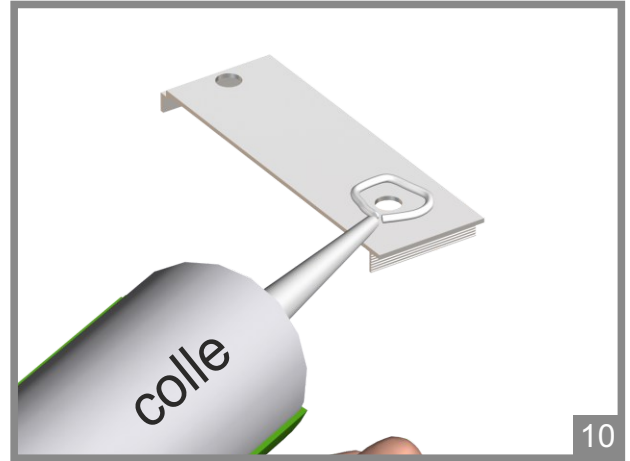
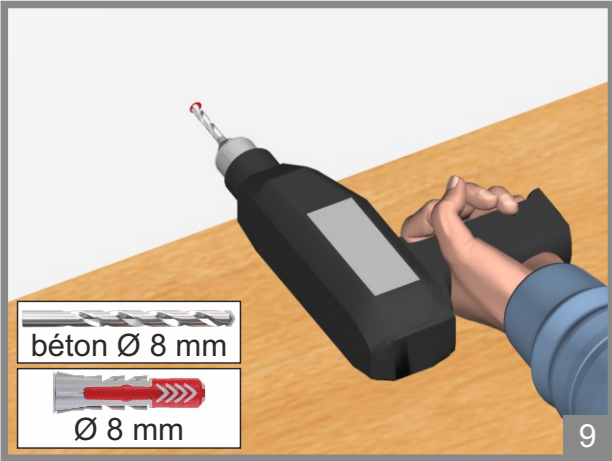
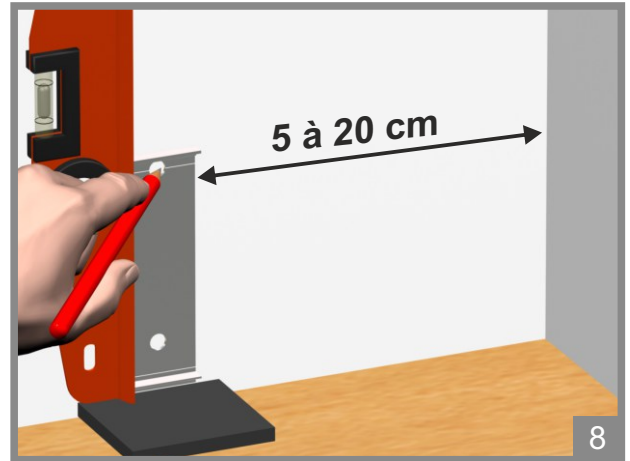
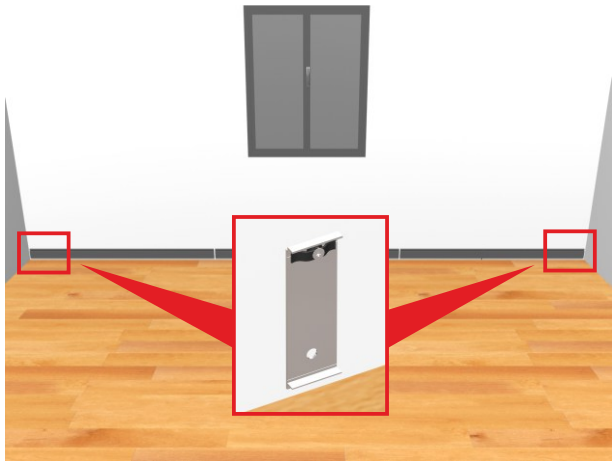
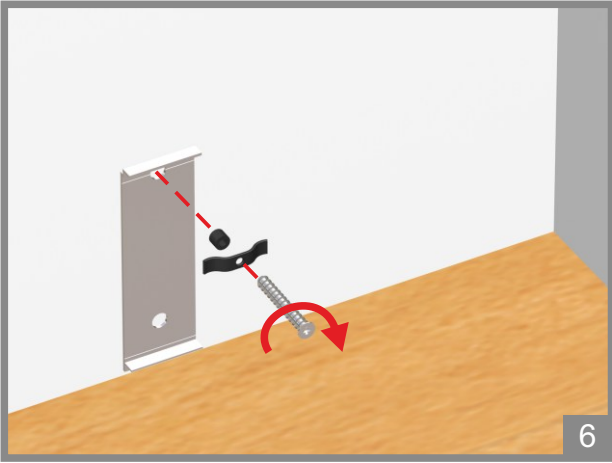

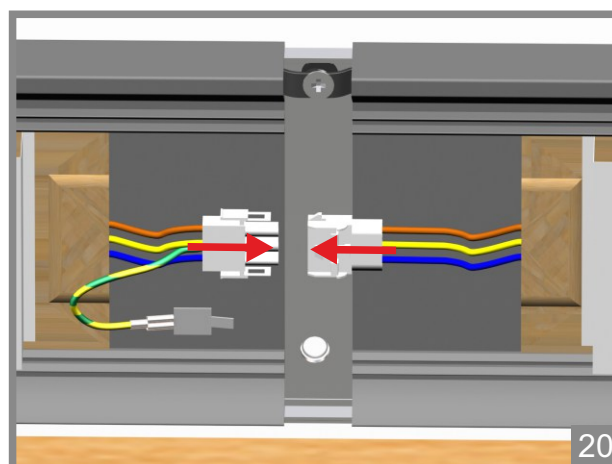
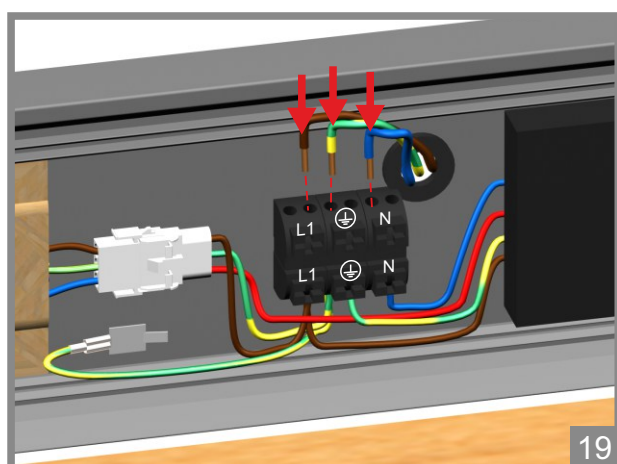
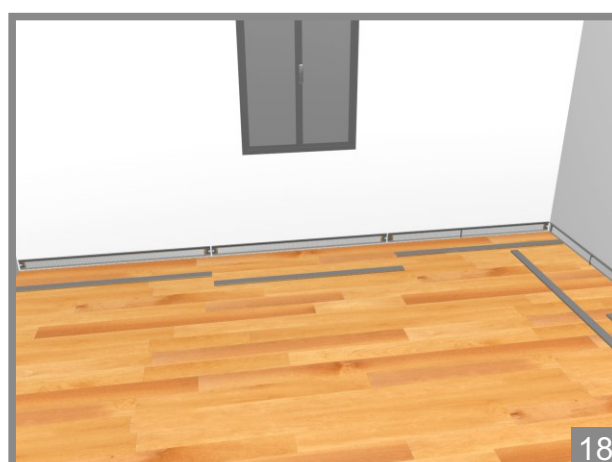
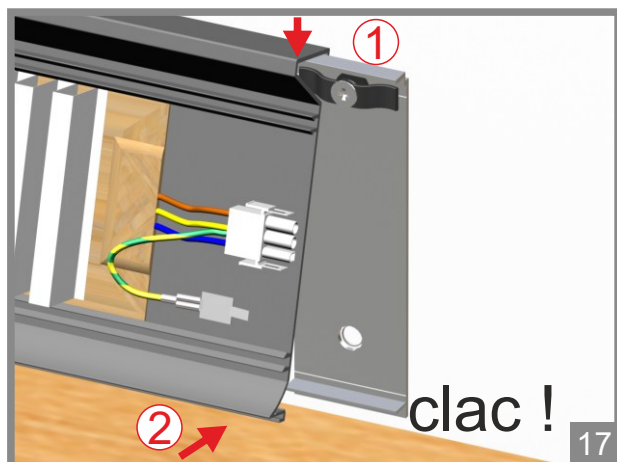
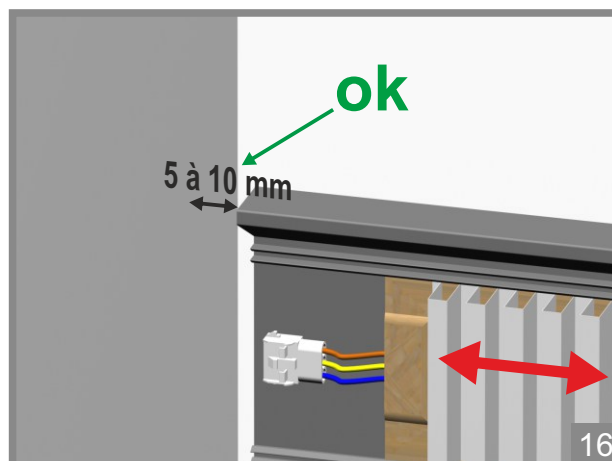
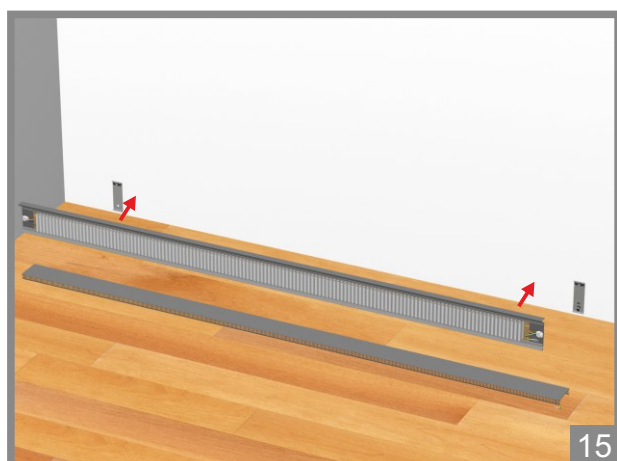
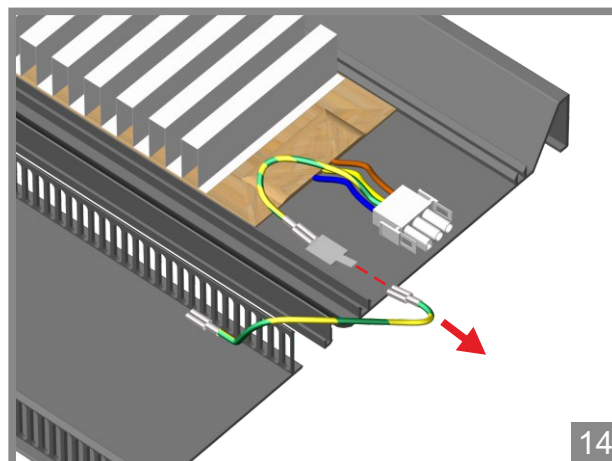
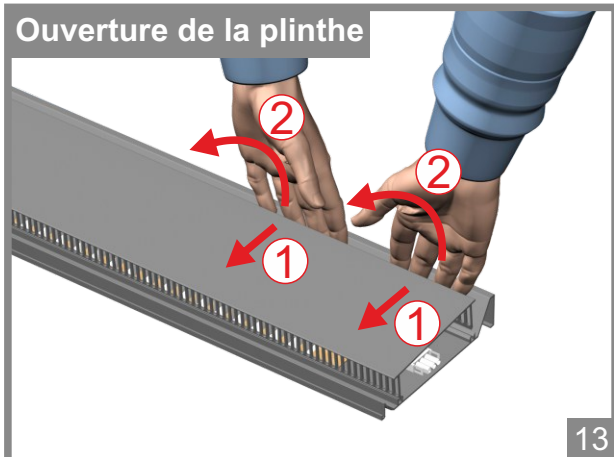

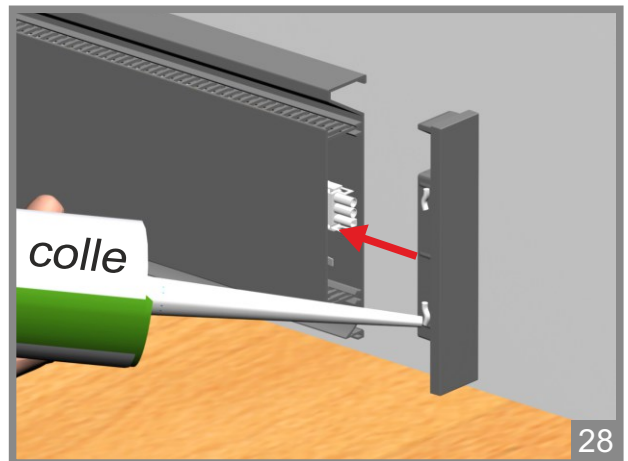
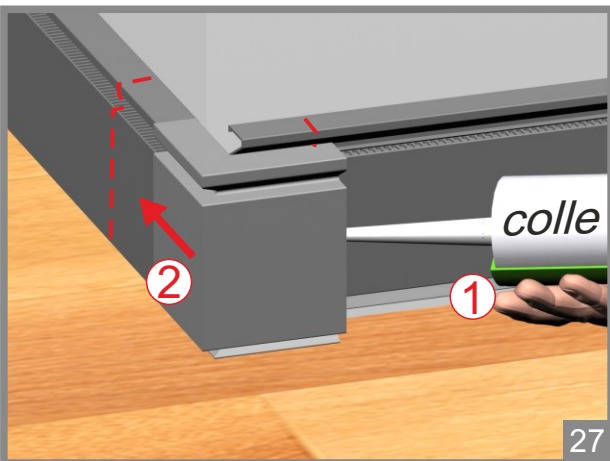
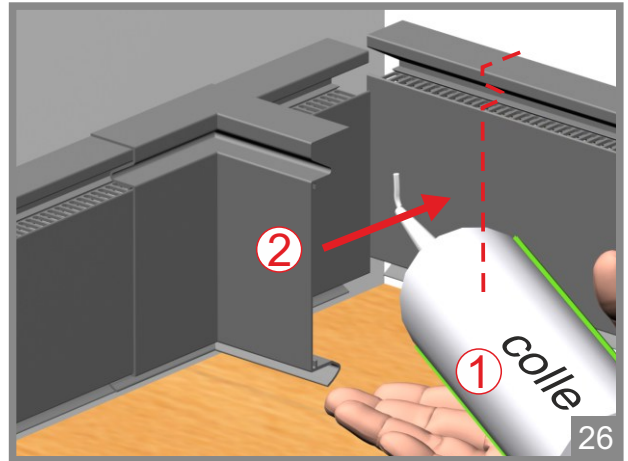
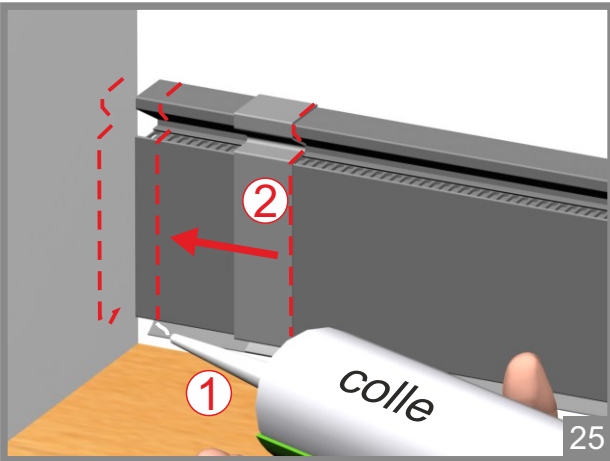
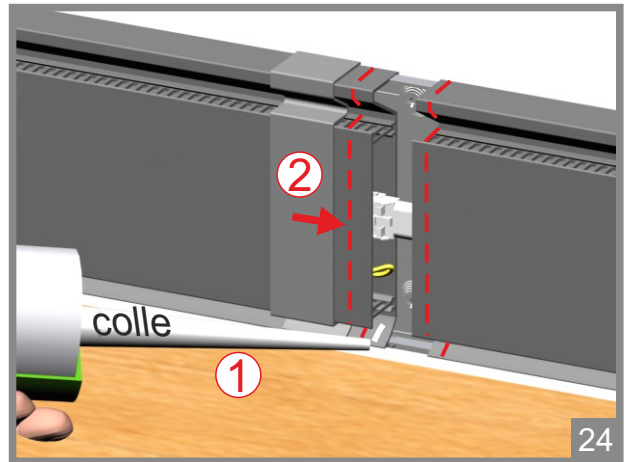
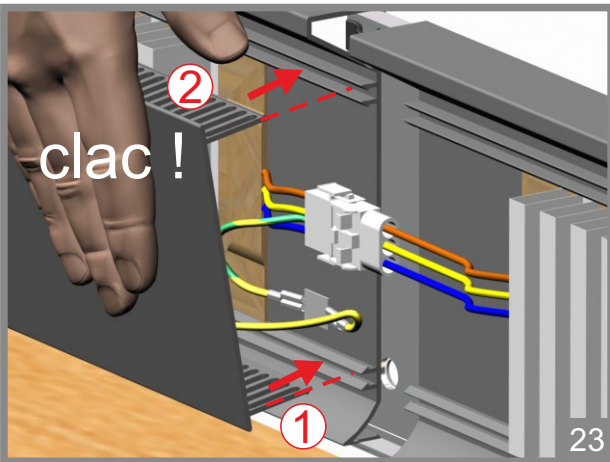
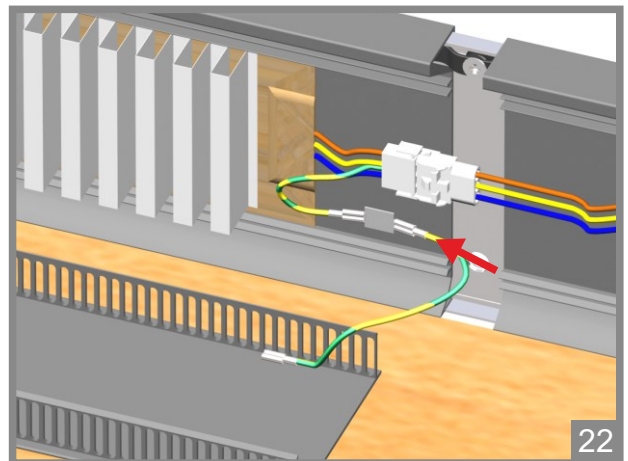
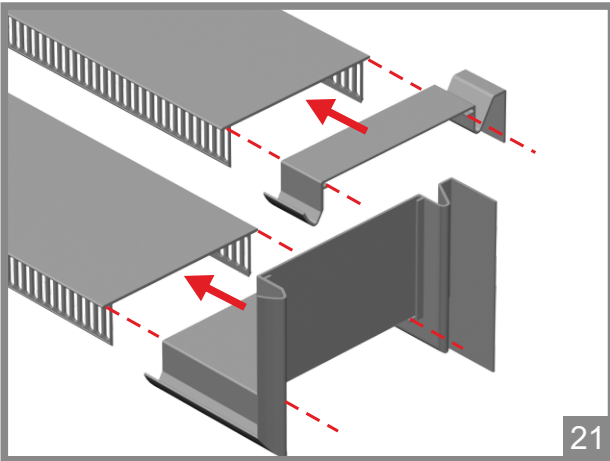

Retirer la plinthe

